

E00-2300 - 1 EA.
BOLT AN3-4A (3/16 X 1/2)
1" CUSHION LOOP CLAMP TO
7/8" CUSHION LOOP CLAMP

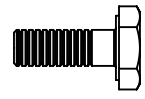

E00-2305 - 2 EA.
BOLT AN3-11A (3/16 X 1-1/8)
CYCLIC CONTROL ROD END PLUG
AND DUAL LATERAL SHAFT

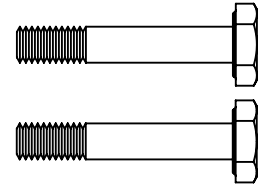

E00-2308 - 2 EA.
BOLT AN3-15A (3/16 X 1-5/8)
CYCLIC CLEVIS AND CYCLIC STICK

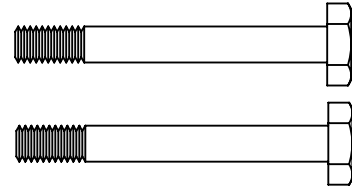

E00-2402 - 6 EA.
BOLT 1/4-28 X 1 GRADE 8
CYCLIC CLEVIS AND SHAFT STOPS

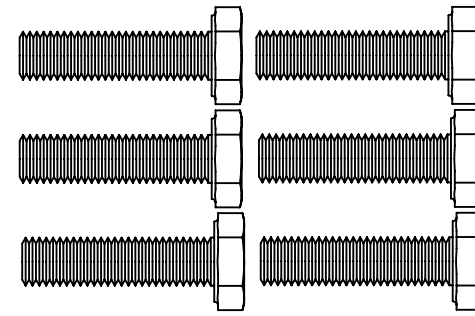

E00-2414 - 2 EA.
BOLT AN4-23A (1/4 X 2-3/8)
CYCLIC CLEVIS TO
CYCLIC SHAFT WELDMENT



E00-2501 - 2 EA.
BOLT AN5H-4A (5/16 X 1/2)
AIRFRAME AND CYCLIC SHAFT

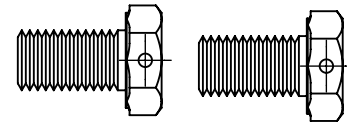

E00-2507 - 1 EA.
BOLT AN5-10A (5/16 X 1)
MALE ROD END ON CONTROL T
AND SHAFT WELDMENT

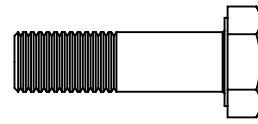

E00-2510 - 3 EA.
BOLT AN5-12A (5/16 X 1-1/4)
2 EA. MALE ROD END FROM
CYCLIC CLEVIS TO LATERAL SHAFT
1 EA. MALE ROD END FROM PILOT CYCLIC
CLEVIS TO CYCLIC CABLE CONTROL T

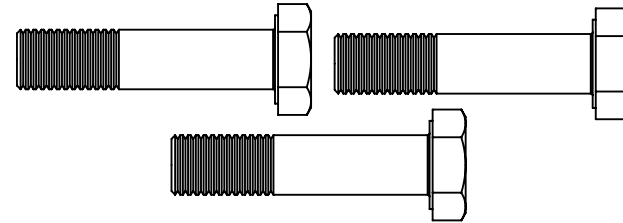

E00-3301 - 7 EA.
NUT 3/16 FIBERLOCK AN365-1032A
1 EA. CUSHION LOOP CLAMP
2 EA. CONTROL CABLE E00-2305
2 EA. CONTROL CABLE E00-2308

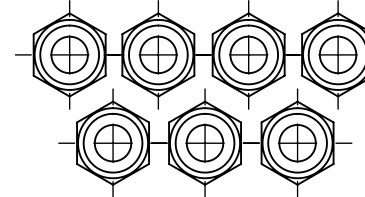

E00-3401 - 8 EA.
JAM NUT 1/4 AN316-4R
4 EA. CYCLIC CLEVIS STOPS
4 EA. CYCLIC SHAFT STOPS

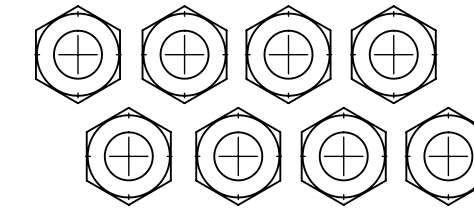

E00-3402 - 10 EA.
NUT 1/4-28 FIBERLOCK AN365-428A

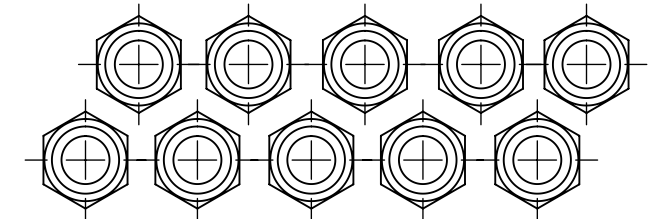

E00-3500 - 4 EA.
NUT 5/16-24 FIBERLOCK AN365-524A

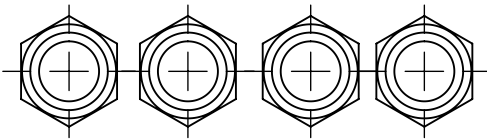

E00-3501 - 6 EA.
NUT 5/16 JAM AN316-5R
MALE ROD END

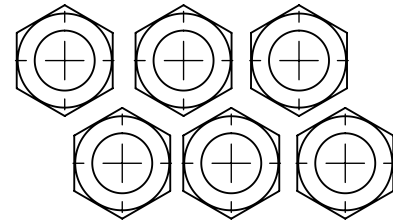

E00-4301 - 14 EA.
WASHER 3/16 REGULAR AN960-10

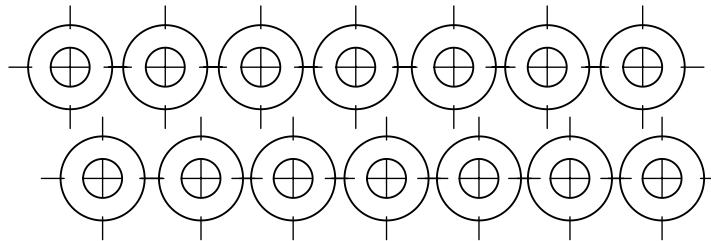

E00-4403 - 4 EA.
WASHER 1/4 FENDER AN970-4
CYCLIC CLEVIS AND CYCLIC SHAFT WELDMENT

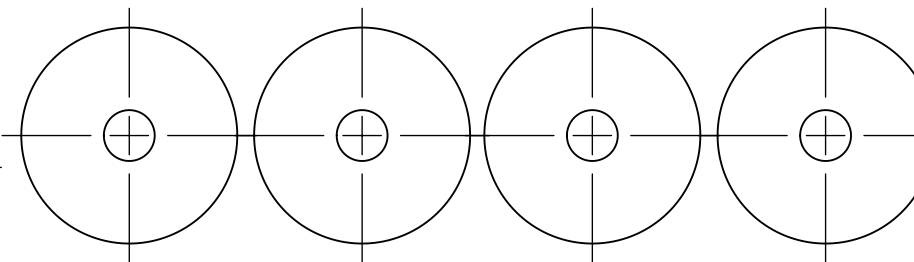

E00-4501 - 8 EA.
WASHER 5/16 REGULAR AN960-516
CYCLIC CLEVIS AND SHAFT WELDMENT

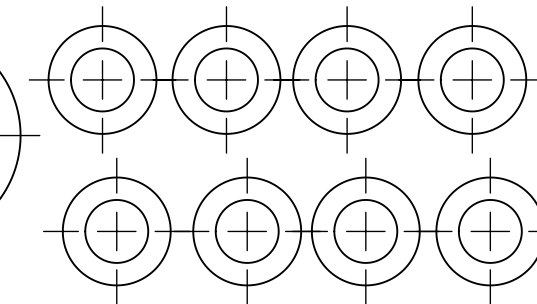

E00-4502 - 4 EA.
WASHER 5/16 LARGE MS15795-11
MALE ROD END BOLT WASHER

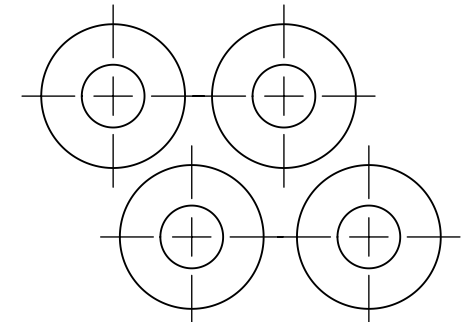

E00-6201 - 4 EA.
RIVET 1/8 X 1/8 STEEL POP
CROSS SHAFT MT BUSHING

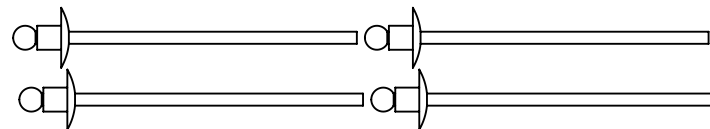

E00-9114 - 1 EA.
CLAMP 7/8" CUSHION LOOP
RETAINER CLAMPS FOR CABLES

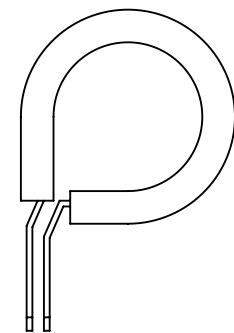

E00-9115 - 1 EA.
CLAMP 1" CUSHION LOOP
RETAINER CLAMPS FOR CABLES

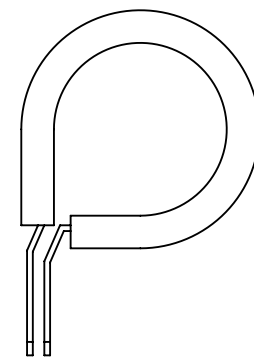

E14-1150 - 6 EA.
ROD END MALE 5/16"
2 EA. DUAL LATERAL SHAFT
4 EA. CYCLIC CABLE CONTROL T

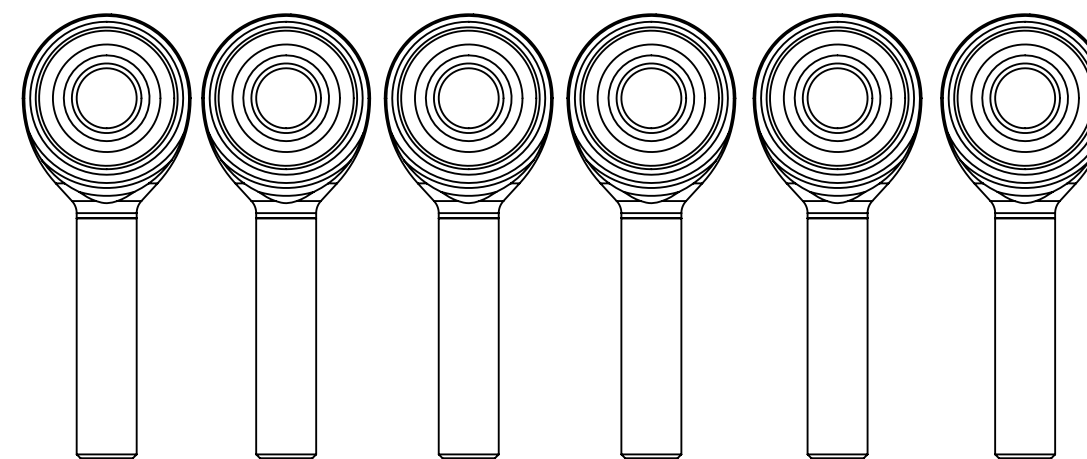

E14-1190 - 2 EA.
BUSHING, NYLON PIVOT
CYCLIC SHAFT WELDMENT

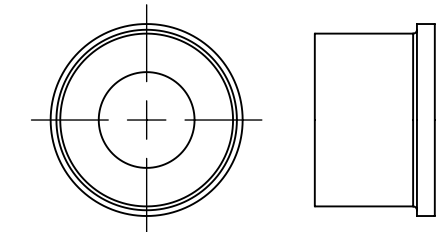

E00-4402 - 4 EA.
WASHER 1/4 LARGE
CYCLIC CLEVIS AND
CYCLIC SHAFT WELDMENT

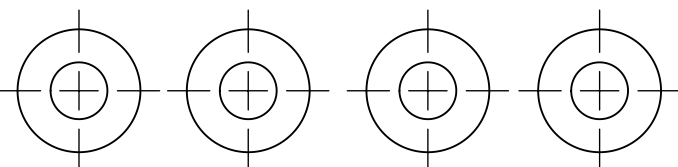

E14-1241 - 4 EA.
BUSHING, NYLON
CYCLIC CLEVIS

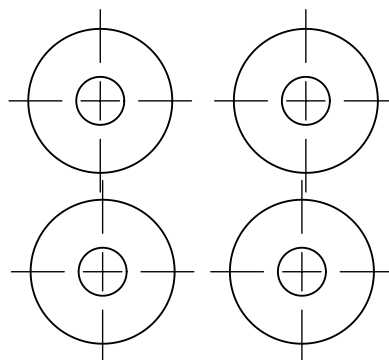

E14-6120 - 4 EA.
CYCLIC CABLE CONTROL T

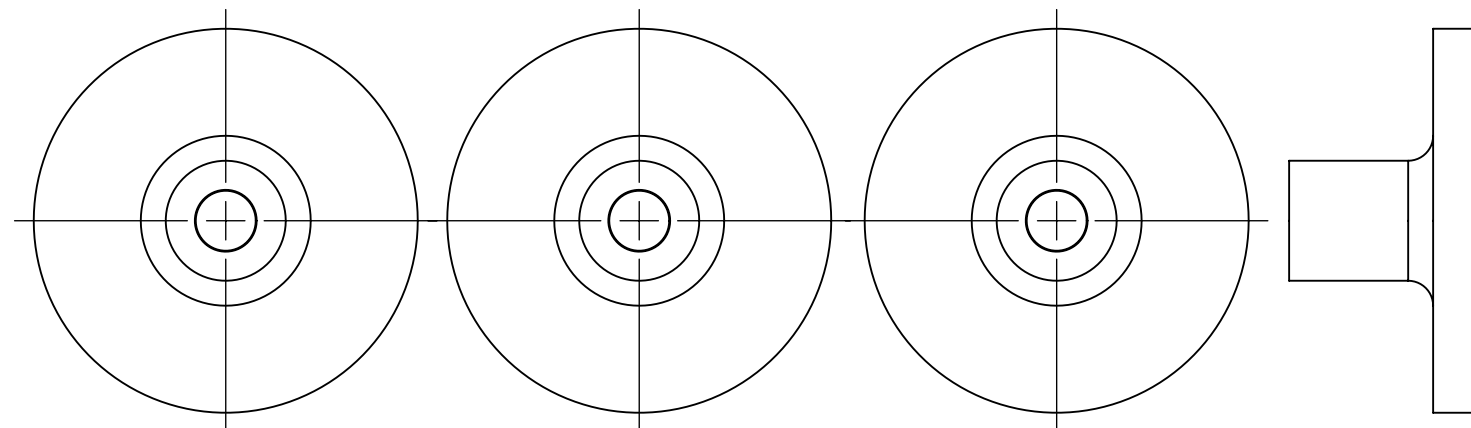

E14-6130 - 2 EA.
CYCLIC CONTROL ROD END PLUG

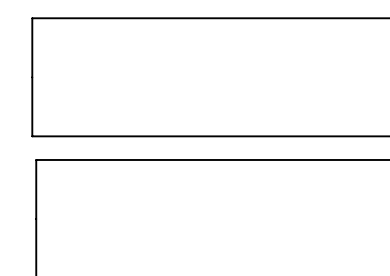

E14-6131 - 2 EA.
CROSS SHAFT MOUNT BUSHING

